

**WAGNER**



**SUPERFINISH**  
**Diaphragm pump**

**BE UNSTOPPABLE!**

[wagner-group.com/contractor](http://wagner-group.com/contractor)

	SUPERFINISH 23 PLUS HEA	SUPERFINISH 23 PLUS AIRLESS ENAMEL CART VERSION	SUPERFINISH 23 PLUS TEMPSRAY CART VERSION	SUPERFINISH 23 PLUS AIRCOAT ENAMEL CART VERSION	SUPERFINISH 33 PLUS
Spraying method					
Product image (may differ)					
Art. No.	2384153	2341492	2341496	2341490	2388259
Categorie	DPFSF	DPFSF	DPFSF	DPFSF	DPFSF
Technology					
Weight	29 kg	29 kg	29 kg	29 kg	50 kg
Motor output	1.3 kW	1.3 kW	1.3 kW	1.3 kW	2.2 kW
Drive					
Voltage	230 V / 50 Hz	230 V / 50 Hz	230 V / 50 Hz	230 V / 50 Hz	230 V / 50 Hz
Max. nozzle size	0.023"	0.023"	0.023"	0.023"	0.033"
Max. operating pressure	250 bar, 25 MPa	250 bar, 25 MPa	250 bar, 25 MPa	250 bar, 25 MPa	250 bar, 25 MPa
Max. delivery rate	2.6 l/min	2.6 l/min	2.6 l/min	2.6 l/min	4.2 l/min
Max. viscosity	20.000 mPas	20.000 mPas	20.000 mPas	20.000 mPas	20.000 mPas
Recommended max. hose length	30 m	30 m	30 m	10 m	60 m
Suction system	rigid	hopper	hopper	hopper	rigid
Two-position cart	✓	✓	✓	✓	✓
Multifunction switch	✓	✓	✓	✓	✓
Material					
Recommended intensity					

	SUPERFINISH 33 PRO
Spraying method	
Product image (may differ)	
Art. No.	2388260
Categorie	DPFSF
Technology	
Weight	43 kg
Motor output	2.2 kW
Drive	
Voltage	230 V / 50 Hz
Max. nozzle size	0.033"
Max. operating pressure	250 bar, 25 MPa
Max. delivery rate	4.2 l/min
Max. viscosity	20.000 mPas
Recommended max. hose length	60 m
Suction system	flexible
Two-position cart	-
Multifunction switch	-
Material	
Recommended intensity	

Water and solvent-based lacquers, lacquer paints, oils, separating agents

Synthetic resin varnishes, PVC lacquers, 2K lacquers

Primers, fillers

Fire protection, rust protection paints

Emulsion and latex paints, adhesives, sealants

Exterior paints, roof coatings, floor coatings, textured paint

Structural waterproofing, bituminous coatings

Filler

Plaster

Residential

Large residential

Commercial

XVLP / HVLP

AirCoat

Piston pump

Double diaphragm pump

Electric

Explosion-protection

FineSpray

Airless

Diaphragm pump

Turbine

Pneumatic

TempSpray

Plaster spraying

Spiral pumps

Petrol-driven

# SUPERFINISH 23 PLUS HEA SPRAYPACK



Compact – light and yet robust

- **Innovative, low-pressure airless technology:** up to 55% less overspray
- **Compact:** Smallest in its class, mobile and light
- **For medium-sized emulsion jobs**
- **Robust:** Ideal for demanding construction site use
- **PumpRunner:** Perfect for clean, tidy transport



# SUPERFINISH 23 PLUS AIRLESS ENAMEL SPRAYPACK



The perfect solution for small paint jobs using diaphragm technology

- **Entry-level Airless spraypack**
- **Straightforward handling and simple operation:** Multifunction switch for greater safety - It is impossible to turn the unit on and off under pressure
- **Improved performance:** No-maintenance brushless motor



- **FineFinish painting:** with hopper and the special FineFinish nozzle

**Large variety of materials with QLS long-stroke technology:** The optimised hydraulics and special valve technology make it possible

**Multifunction switch for extra safety:** on/off as well as circulation and spray mode. This prevents accidental switching on or off while the system is under pressure

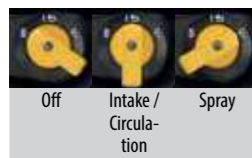

**Superb Spray Surface Quality:** with the Vector Grip Airless gun. Light in weight with a long service life

**Infinitely variable pressure regulation:** from 0 to 250 bar

**Direct suction:** straight from the container for trouble-free working. Inclusive PumpRunner for clean transport included

**HEA** HIGH EFFICIENCY AIRLESS

**T** ≤ 0.023"; **W** 2.6 l/min

SUPERFINISH 23 PLUS HEA SPRAYPACK - DPFSF	2384153
Basic unit, SF 23 Plus, cart version	-
Suction system complete, for SF 23 Plus, incl. PumpRunner	2342879
HP hose DN6, 27 MPa, NPSM 1/4", 15 m	9984574
Pressure gauge set assy. HEA (MPa)	2383995
Airless gun Vector Grip, 1/4", incl. TradeTip 3 nozzle holder, with 2- and 4-finger trigger	538043
HEA ProTip 519	554519

ACCESSORIES	
HEA ProTip, different sizes (e.g. tip 211 - Art.No. 517211)	554XXX
5 litre hopper, M36x2	341265
Nozzle extension, 30 cm, G-thread	556075
Nozzle extension, 60 cm, G-thread	556077
Hydraulic oil Divinol 1 litre	21061
TipClean; 200ml	2400214

**Large variety of materials with QLS long-stroke technology:** The optimised hydraulics and special valve technology make it possible

**Infinitely variable pressure regulation:** from 0 to 250 bar

**Multifunction switch for extra safety:** on/off as well as circulation and spray mode. This prevents accidental switching on or off while the system is under pressure



**Superb Spray Surface Quality:** with the Vector Grip Airless gun. Light in weight with a long service life

**Infinitely variable pressure regulation:** from 0 to 250 bar

**Multifunction switch for extra safety:** on/off as well as circulation and spray mode. This prevents accidental switching on or off while the system is under pressure

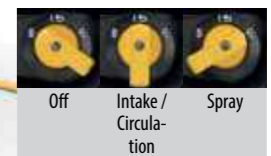

**T** ≤ 0.023"; **W** 2.6 l/min

SUPERFINISH 23 PLUS AIRLESS ENAMEL - CART VERSION DPFSF	2341492
Basic unit, SF 23 Plus on cart	-
5 litre hopper, M36x2	341265
HP hose DN3, 27 MPa, NPS 1/4", 7.5 m	9984583
Airless gun Vector Grip, 1/4", incl. TradeTip 3 nozzle holder, with 2-finger trigger	538042
2SpeedTip, L10, 208 / 510	271042
Gun filter red, 1 piece, 180 MA, 0.084 mm MW, extra fine	34383

ACCESSORIES	
TradeTip 3 FineFinish nozzles, different sizes (e.g. tip 210 - Art. No. 517210)	554XXX
2SpeedTip, different sizes	271XXX
5 litre hopper, M36x2	341265
Nozzle extension, 30 cm, G-thread	556075
Nozzle extension, 15 cm, G-thread	556074
Hydraulic oil Divinol 1 litre	21061
TipClean; 200ml	2400214



# SUPERFINISH 23 PLUS TEMPSPRAY SPRAYPACK



## Enamel specialist with heated hose

- **Perfect surface results:** thanks to heated hose
- **Also ideal for:** highly viscous materials such as enamels with high VOC content
- **The TempSpray system heats the material directly in the hose:** thereby ensuring perfect viscosity without the need for thinning, as well as optimum paint application



**Perfect surface quality with Temp-Spray:** Thanks to warming up the coating material a very soft spray pattern is generated. This increases the atomisation quality. Further advantages are: reduced overspray, perfect viscosity without diluting and much more

**Large variety of materials with QLS long-stroke technology:** The optimised hydraulics and special valve technology make it possible

**Superb Spray Surface Quality:** with the Vector Grip Airless gun. Light in weight with a long service life

**Infinitely variable pressure regulation:** from 0 to 250 bar

**Multifunction switch for extra safety:** on/off as well as circulation and spray mode. This prevents accidental switching on or off while the system is under pressure

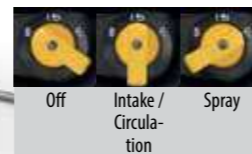

**T** ≤ 0.023" ; **W** 2.6 l/min

### SUPERFINISH 23 PLUS TEMPSPRAY SPRAYPACK - DPFSF 2341496

Basic unit, SF 23 Plus on cart	-
5 litre hopper, M36x2	341265
TempSpray H 126 basic unit, 10 m	2311659
Airless gun Vector Grip, 1/4", incl. TradeTip 3 nozzle holder, with 2- and 4-finger trigger	538043
2SpeedTip, L10, 208 / 510	271042
Gun filter red, 1 piece, 180 MA, 0.084 mm MW, extra fine	34383

### ACCESSORIES

TradeTip 3 FineFinish nozzles, different sizes (e.g. tip 210 - Art. No. 517210)	554XXX
2SpeedTip, different sizes	271XXX
5 litre hopper, M36x2	341265
Nozzle extension, 30 cm, G-thread	556075
Nozzle extension, 60 cm, G-thread	556077
Hydraulic oil Divinol 1 litre	21061
TipClean; 200ml	2400214

# SUPERFINISH 23 PLUS AIRCOAT ENAMEL SPRAYPACK



## Mobile complete solution for enamel work

- **With AirCoat technology:** Particularly fine atomisation for a perfect finish
- **Perfectly matching components:** Minimal overspray and high application efficiency
- **Particularly easy handling**
- **The industry standard:** quality-crafted by WAGNER



- **Suitable for:** non EX environments

**Large variety of materials with QLS long-stroke technology:** The optimised hydraulics and special valve technology make it possible

**Also available with AirBoost 100 compressor (art. no. 2353393)**



**Ergonomic AirCoat gun AC 4600:** The low air consumption and the soft spray pattern guarantee perfect painting results

**Infinitely variable pressure regulation:** from 0 to 250 bar

**Multifunction switch for extra safety:** on/off as well as circulation and spray mode. This prevents accidental switching on or off while the system is under pressure

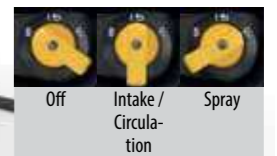

**T** ≤ 0.023" ; **W** 2.6 l/min

### SUPERFINISH 23 PLUS AIRCOAT ENAMEL SPRAYPACK - DPFSF 2341490

Basic unit, SF 23 Plus on cart	-
5 litre hopper, M36x2	341265
HP double hose, material DN3, max. 27 MPa, air DN6, 1/4", 7.5 m	9984595
AirCoat gun AC 4600 Professional, incl. blue air cap and holder	394156
Nozzle ACF3000 11/40	379411
AirCoat regulator, fitting kit	340250

### ACCESSORIES

Compressor AirBoost 100	2347935
AirCoat nozzle ACF 3000, different sizes	379XXX
Blue air cap, incl. union nut	394911
Green air cap, incl. union nut	394912
Red air cap, incl. union nut	394910
Union nut complete	394921
Gun filter, yellow, fine, set of 10 pieces,	97023
Gun filter, red, extra fine, set of 10 pieces	97022

# DIAPHRAGM PUMP

## Effective material intake – broad range of materials

Do you want to process different materials, from primers to silicate paints with just one device? Then a WAGNER diaphragm pump is the ideal choice. This powerful, maintenance-friendly technology transports the material via a lifting motion of the diaphragm. Diaphragm pumps from WAGNER are robust, easy-to-use construction site and workshop units.

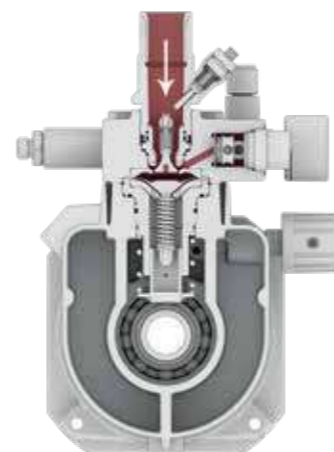

### The perfect companion for painters and affiliated trades:

The patented Quality-Long-Stroke (QLS) technology from WAGNER, with its optimised hydraulics and special valve technology, means that the material is taken in much more effectively compared to diaphragm pumps from other manufacturers. As a result, a broad range of different materials, such as primers and release agents, primers and lacquers, emulsion and silicate paints, fabric adhesives, corrosion and flame retardants can be processed. In the domain of specially filled materials such as bitumen, fire protection and fillers, piston and spiral pumps are the specialists. Electrically operated diaphragm pumps can be used in both Airless and AirCoat processes with additional air atomization.

### 1. ALSO SUITABLE FOR VERY SMALL VOLUMES:

Diaphragm pumps have up to 58 per cent\* less material in their system. The device's small cross-sections means that it can also be operated with tiny amounts of material. This saves resources both when changing material and during the cleaning process.

### 2. LOW-MAINTENANCE AND DURABLE:

The reduced lifting frequency of the diaphragm means that the already lower number of wear parts are placed under significantly less stress. This significantly reduces maintenance costs\*. However, should a repair be necessary, the corresponding components can be easily replaced directly on site and in the case of both valves for example, within minutes.

### Fire retardants for joiners, metalworkers and similar trades :

Pneumatic double diaphragm pumps are ideal for the wood and metal processing industry. In this case, the material is transported via the lifting motion of two opposing diaphragm which generates a lower-pulsation material flow. This allows you to work with materials which are particularly sensitive to shearing and moisture and with premixed two-component materials. WAGNER double diaphragm pumps are explosion-proof and operated by compressed air, which means that they can be used safely in workshops and in painting booths.

### 3. FINE AND EVEN SPRAY PATTERN:

Diaphragm technology reduces the pulsation of the material flow, which avoids any irregularities in the spray pattern. It remains fine and even. The piston's switching point is also dispensed with in a diaphragm pump.

# HEA HIGH EFFICIENCY AIRLESS

## HEA - HIGH EFFICIENCY AIRLESS

### up to 55% less overspray with maximum control

Do you already value the advantages of airless technology, such as control and comfort? Then you'll be inspired by the new HEA ProTip airless nozzle from WAGNER. It achieves perfect surface results at a much lower spray pressure. Compared to conventional airless technology, the spray edges are softer, the result more even and free from streaks on the edges.



### More efficiency for prolonged working:

Thanks to the HEA nozzle technology, the spray pressure can be significantly lowered. This reduces the overspray by up to 55 percent. Apart from the much lower masking effort required, this also has a positive effect on the gun's recoil. Working with a WAGNER airless pump is made even easier and more convenient with the HEA technology.

### Robust and durable:

The nozzle wears more slowly due to the lower spray pressure. This means that HEA nozzles can be used for considerably longer than conventional airless nozzles. Loads on the pump are also reduced due to the lower pressure, with handling of the gun also improved.

### 1. MAXIMUM CONTROL:

The gentle spray pattern ensures a more even surface when overlapping the paths and avoids hard edges. This leads to a simple and easy-to-learn technique – even for inexperienced users.

### 3. INCREASED EQUIPMENT LIFESPAN:

Even the lifespan of the spray device itself is prolonged: the lower spraying pressure with High Efficiency Airless means that the system and its components are under less strain.

### 2. PERFECT SURFACE QUALITY:

High Efficiency Airless ensures a uniform and even application on all surfaces and therefore offers excellent surface quality – especially when compared to conventional applications with a brush and roller.

## SPRAYPATTERN AT LOW PRESSURE

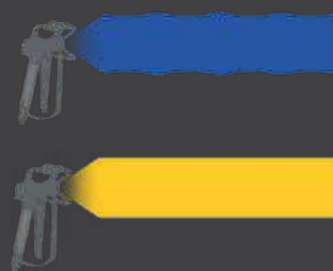

irregular spray pattern from the piston pump

## BENEFITS

- Large range of material
- Flexible material intake
- Fully adjustable pressure regulation from 0 - 25 MPa
- QLS technology with longer stroke
- Low-pulsation
- Robust and very low-maintenance
- Simple maintenance
- Low noise

even spray pattern from the diaphragm pump

\*Compared to other piston pumps on the market

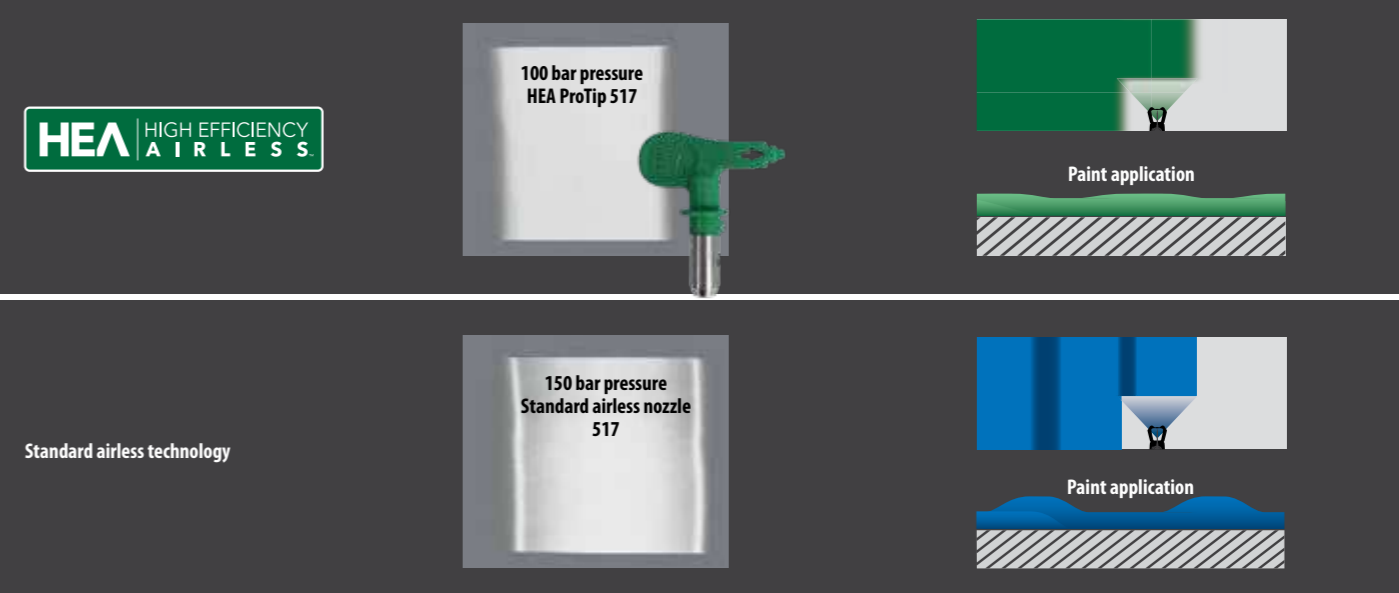

\*Compared to other airless nozzles on the market



# SUPERFINISH 33 PLUS SPRAYPACK



The extremely easy-to-use diaphragm pump for every project

- **Versatile applications:** The SuperFinish 33 Plus can process a diverse range of materials and service a wide variety of industries and project sizes.
- **Optimum efficiency and productivity:** With a delivery rate of 4.3 litres per minute, the SuperFinish 33 Plus is the most powerful WAGNER diaphragm pump in the professional segment.



- **Practical multi-gun operation:** For parallel use, a distributor adapter for connecting up to three airless guns is available separately as an accessory.
- **Flexible use:** Switch the pump position with a single hand movement from working with the top container to the rigid suction system with fine filter meshes.

**Ergonomic working:** with the high quality Vector Grip Airless gun. It is light, robust and highly ergonomic

**Modular variants:** two-position cart for use with the top container or rigid suction system



**Includes a handy 230 V socket :** to connect additional devices, such as TempSpray

**Inlet pusher valve:** for a high operating reliability and easy commissioning. Just the press of a finger, and the valve is free

**Illuminated multifunction switch for extra safety:** on/off as well as circulation and spray mode. This prevents accidental switching on or off while the system is under pressure

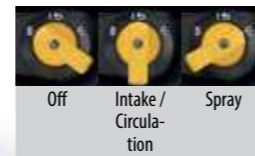

**Direct suction:** straight from the container for trouble-free working – thanks to the special filter with ultra-fine filter mesh

**Robust, building-site-friendly tires:** allow easy transport across even the most challenging terrain

**Integrated toolbox:** including a handy organiser to ensure the right tools and accessories are always at hand



# NEW

≤ 0.033"; 4.2 l/min

**SUPERFINISH 33 PLUS SPRAYPACK - DPFSF** 2388259

SuperFinish 33 Plus, basic unit	-
Suction system, rigid, D38	2370310
HP hose DN6, max. 27 MPa, NPSM 1/4", 15 m	9984574
Airless gun Vector Grip, 1/4", incl. TradeTip 3 nozzle holder, with 2- and 4-finger trigger	0538043
2SpeedTip nozzle D20 115/421	0271046

## ACCESSORIES

TradeTip 3 FineFinish nozzles, different sizes (e.g. tip 211 - Art. No. 517211)	554XXX
TradeTip 3 FineFinish nozzles, different sizes	554XXX
Nozzles TradeTip 3, different sizes	553XXX
Nozzles 2SpeedTip, different sizes	271XXX
5 litre hopper, M36x2	341265
Nozzle extension, 30 cm, G-thread	556075
Nozzle extension, 60 cm, G-thread	556077
Hydraulic oil Divinol 1 litre	21061

## HANDY ACCESSORIES SF 33 PLUS

### AIRLESS GUNS

Vector Pro, 1/4", incl. TradeTip 3 nozzle holder, with 4-finger trigger	538040
Vector Pro, 1/4", incl. TradeTip 3 nozzle holder, with 2-finger trigger	538041
Vector Grip, 1/4", incl. TradeTip 3 nozzle holder, with 2- and 4-finger trigger	538043
Vector Infinity, G-thread 1/4", incl. TradeTip 3 nozzle holder, with 2-finger trigger	538085
AG 14, G-thread 1/4", incl. TradeTip 3 nozzle holder	0502081A

### AIRLESS HOSES

HP hose DN3, max. 27 MPa, NPS 1/4", 7,5 m	9984583
HP hose DN6, max. 27 MPa, NPS 1/4", 15 m	9984574
HP hose DN6, max. 27 MPa, NPS 1/4", 30 m	9984575
HP hose DN10, max. 25 MPa, 3/8" NPSM, 15 m	2336583

### AIRLESS NOZZLES

2SpeedTip nozzles, different sizes	271XXX
TradeTip 3 nozzles, different sizes	553XXX
HEA ProTip nozzles, different sizes	554XXX

### GUN FILTERS

Gun filter red, 10 pieces, 180 MA, 0.084 mm MW, extra fine	97023
Gun filter yellow, 10 pieces, 100 MA, 0.14 mm MW, fine	97022
Gun filter white, 10 pieces, 50 MA, 0.31 mm MW, medium	97024

### AIRCOAT ACCESSORIES

AirCoat gun AC 4500, incl. blue air cap and holder	2368269
HP double hose, material DN3, max. 27 MPa, air DN6, 1/4", 7.5 m	9984595
AirCoat regulator, fitting kit	340250
AirCoat nozzles ACF3000 (different sizes)	379XXX

### OTHER

InlineRoller packaged in a plastic box, incl. HP hose DN4, 27 MPa, 7.5 m, extension complete 0.5 m, woven plush paint roller short pile 13 mm, and so on	345010
Adapter for multi-gun operation (up to 3 guns)	2304430
Double connector A = 1/4" x 1/4"	34038
Coupling sleeve I = 1/4" NPSM x A = 3/8" NPSM, 27 MPa	179732
Hopper set, 5 litre, M36x2	341265
PumpRunner	2306987
Nozzle extension, 15 cm, G-thread	556074
Hose reel HR30, M16x1.5	2392523

## RECOMMENDED USE

### MATERIALS:

Water and solvent-based lacquers, lacquer paints, oils, separating agents	Synthetic resin lacquers, PVC lacquers, 2K lacquers
Primers, fillers	Fire protection, rust protection paints
Emulsion and latex paints, adhesives, sealants	Exterior paints, roof coatings, floor coatings

### OBJECT SIZE:



For different project sizes

## TECHNICAL DATA

Motor output	2.2 kW
Voltage	230 V / 50 Hz
Max. operating pressure	250 bar, 25 MPa
Max. delivery rate	4.3 l/min
Delivery rate at 12 MPa spray pressure	3.8 l/min
Max. nozzle size	0.033"
Weight	50 kg

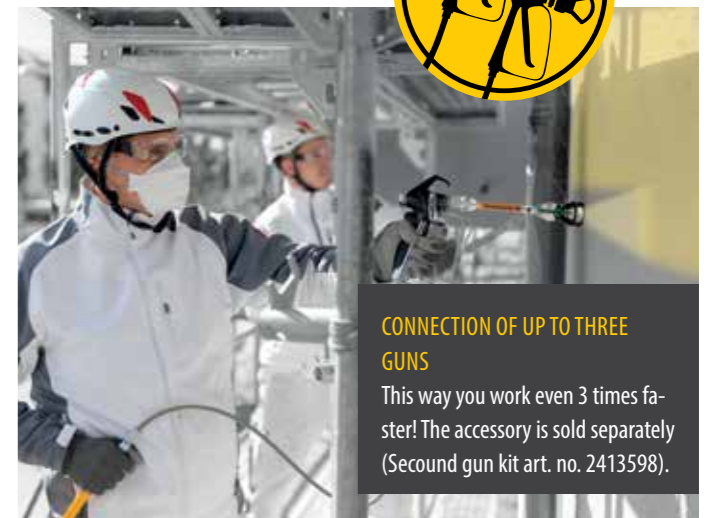

### CONNECTION OF UP TO THREE GUNS

This way you work even 3 times faster! The accessory is sold separately (Secound gun kit art. no. 2413598).



# SUPERFINISH 33 PRO SPRAYPACK



One diaphragm pump for every project – outstanding performance for indoor and outdoor application

- **Versatile applications:** The SuperFinish 33 Pro can process a diverse range of materials and service a wide variety of industries and project sizes.
- **Optimum efficiency and productivity:** With a delivery rate of 4.3 litres per minute, the SuperFinish 33 Pro is the most powerful WAGNER diaphragm pump in the professional segment.



- **Quality LongStroke Technology (QLS):** For a long service life, easy maintenance and low wear.
- **Practical multi-gun operation:** For parallel use, a distributor adapter for connecting up to three airless guns is available separately as an accessory.

**Ergonomic work:** With the Airless gun Vector Pro. It is light and robust

**Easy to transport:** Robust cart with height-adjustable handle

**Inlet pusher valve:** for a high operating reliability and easy commissioning. Just the press of a finger, and the valve is free

**Large variety of materials with QLS long-stroke technology:** The optimised hydraulics and special valve technology make it possible



**NEW**

**Robust, building-site-friendly tires:** allow easy transport across even the most challenging terrain

**T** ≤ 0.033"; **W** 4.2 l/min

**SUPERFINISH 33 PRO SPRAYPACK - DPF5F** 2388 260

SuperFinish 33 Pro, basic unit	-
Suction system, flexible	34630
HP hose, DN6, PN270, NPSM 1/4", 15m	9984574
Airless gun Vector Pro, 1/4", incl. TradeTip 3 nozzle holder, with 4-finger trigger	0538040
TradeTip3 nozzle 523 incl. white filter	553523

## ACCESSORIES

TradeTip 3 FineFinish nozzles, different sizes (e.g. tip 211 - Art. No. 517211)	554XXX
TradeTip 3 FineFinish nozzles, different sizes	554XXX
Nozzles TradeTip 3, different sizes	553XXX
Nozzles 2SpeedTip, different sizes	271XXX
5 litre hopper, M36x2	341265
Nozzle extension, 30 cm, G-thread	556075
Nozzle extension, 60 cm, G-thread	556077
Hydraulic oil Divinol 1 litre	21061
TipClean; 200ml	2400214



## COLOUR-TESTREPORT



More SprayGuides:  
sprayguide.wagner-group.com

## MACHINE & MATERIAL PERFECTLY MATCHED

The extensive WAGNER SprayGuide offers you test reports from well-known material manufacturers for use with WAGNER spray machines.

Visit [sprayguide.wagner-group.com](http://sprayguide.wagner-group.com) to find out how to set up your machine to match the material you are using, and which paints and lacquers can be sprayed most effectively with WAGNER technology.

- ➔ Search by material type
- ➔ Search by material manufacturer
- ➔ Search by WAGNER machine and systems

# INNOVATION SINCE 1947

Perfect surfaces and added value are our passion. Bringing colour, protection and function to surfaces is our mission. We dedicate all of our technical expertise to your objects and products, and support you with personal service. Using innovative technologies and highly efficient, reliable and user-friendly solutions, we are constantly setting new standards in surface technology.



Anyone purchasing a WAGNER paint spraying unit automatically receives a three-year manufacturer's warranty. But we can do more: If you register online, you can extend this warranty for a further two years, free of charge!

[wagner-group.com/3plus2](http://wagner-group.com/3plus2)



## ACCESSORIES – SUPERFINISH

### HOPPERS

5 litre hopper, M36x2	0341265
5 litre hopper, with TopClean	0341268
20 litre hopper, M36x2	0341266



20-litre hopper with ball valve

### AIRLESS GUNS

Airless gun Vector Pro, 1/4", incl. TradeTip 3 nozzle holder, with 4-finger trigger	0538040
Airless gun Vector Pro, 1/4", incl. TradeTip 3 nozzle holder, with 2-finger trigger	0538041
Airless gun Vector Grip, 1/4", incl. TradeTip 3 nozzle holder, with 2- and 4-finger trigger	0538043
Airless gun Vector Infinity, G-thread 1/4", incl. TradeTip 3 nozzle holder, with 2-finger trigger	0538085
AG 14, G-thread 1/4"; incl. TradeTip 3 nozzle holder	0502081A



Vector Grip guns with adjustable handle size

### AIRLESS NOZZLES + NOZZLE HOLDERS

2SpeedTip nozzles	0271XXX
TradeTip 3 FineFinish nozzles	0554XXX
TradeTip 3 nozzles	0553XXX
HEA ProTip nozzles	0554XXX
Nozzle holder, G-thread 7/8", for TradeTip 3 nozzles	0289390
Nozzle extension 15 cm	556074
Nozzle extension 30 cm	556075

Find an overview of all nozzles in our Download Area on [www.wagner-group.com](http://www.wagner-group.com)



Various airless nozzles for every application

### AIRLESS HOSES

HP hose DN4, max. 27 MPa, M16x1.5, 7.5 m	9984510
HP hose DN6, max. 27 MPa, M16x1.5, 15 m	9984507
HP hose DN6, 27 MPa, NPSM 1/4", 15 m	9984574
HP hose DN4, 27 MPa, NPS 1/4", 7.5 m	9984573

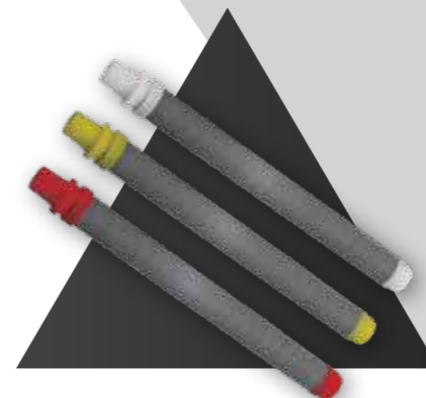

Red, yellow and white plug-in filter - work fast without nozzle blockages

### GUN FILTERS

Gun filter red, set 10 pieces, 180 MA, 0.084 mm MW, extra fine	0097022
Gun filter yellow, set 10 pieces, 100 MA, 0.14 mm MW, fine	0097023
Gun filter white, set 10 pieces, 50 MA, 0.31 mm MW, medium	0097024



AC 4600 gun - the AirCoat gun for the toughest demands

### AIRCOAT GUNS

AC 4500 Professional, incl. blue air cap and nozzle holder	2368269
AC 4500 Professional, incl. red air cap and nozzle holder	2368271
AC 4500 Professional, incl. green air cap and nozzle holder	2368270
Nozzle ACF 3000	379XXX
Nozzle ACF 3000 Plus	321XXX
AC 4600 Professional, incl. blue air cap and holder	394156
AC 4600 Professional, incl. green air cap and holder	394158
AC 4600 Professional, incl. red air cap and holder	394157

### AIRCOAT HOSES

Material DN3, max. 27 MPa, air DN6, 1/4", 7.5 m	9984595
Material DN3, max. 27 MPa, air DN6, 1/4", 10 m	9984596
Material DN4, max. 27 MPa, air DN6, 1/4", 7.5 m	2302378
Material DN4, max. 27 MPa, air DN6, 1/4", 10 m	2302379



PumpRunner - for clean and easy transportation of the pump

### OTHER ACCESSORIES

SpeedShield	0538905
Large volume containers	2309956
Container Connector, for SF 27/31/33	2371930
PumpRunner (only for Rigid Suction System)	2306987
Hose reel (only for SF33)	2392523
TipClean, container incl. special cleaner; 200ml	2400214
TipClean, refill bottle, 1 liter	2400216
Compressor AirBoost 100	2347935
SprayRoller	2411697



# NOTES

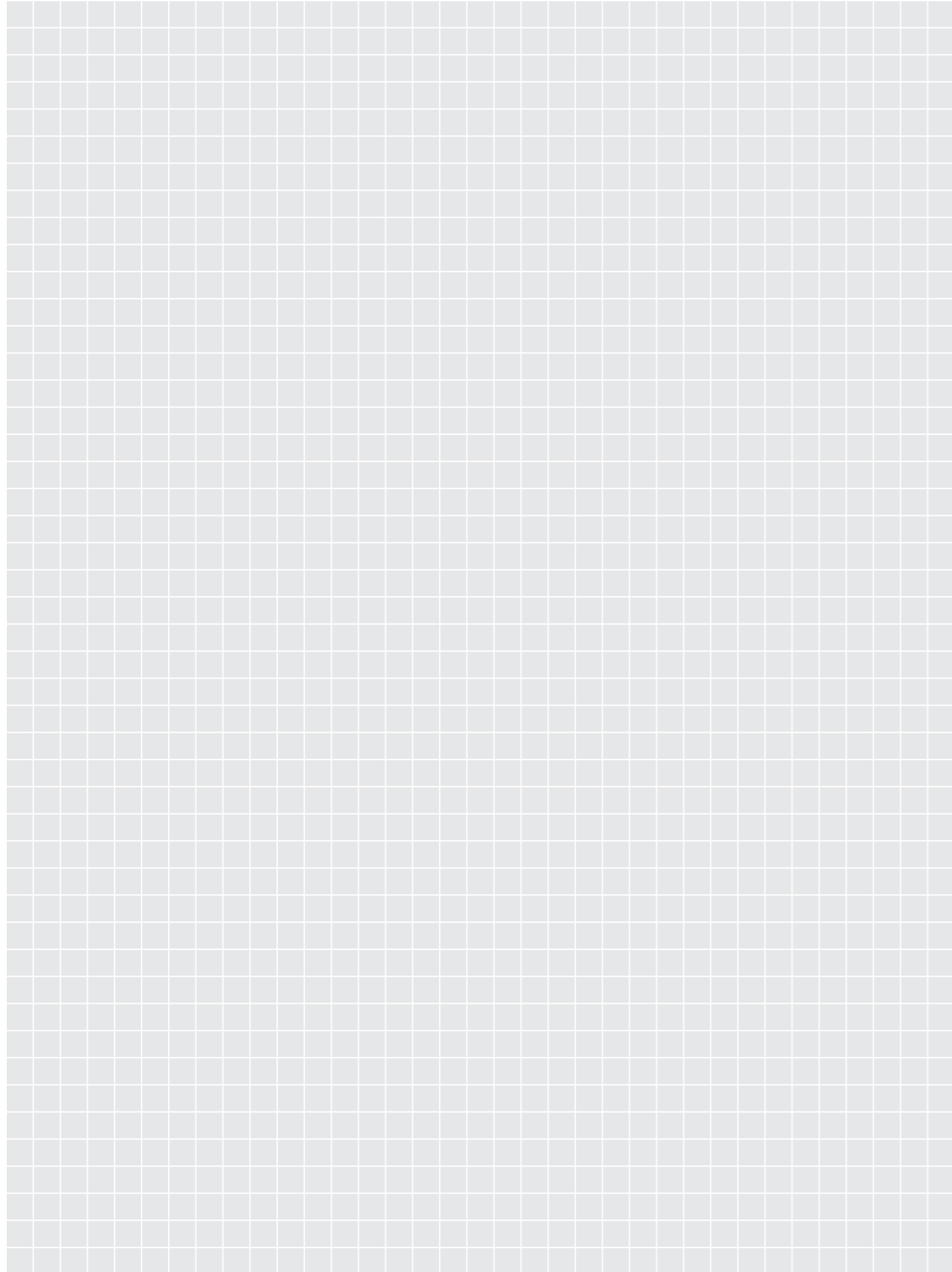

# NOTES

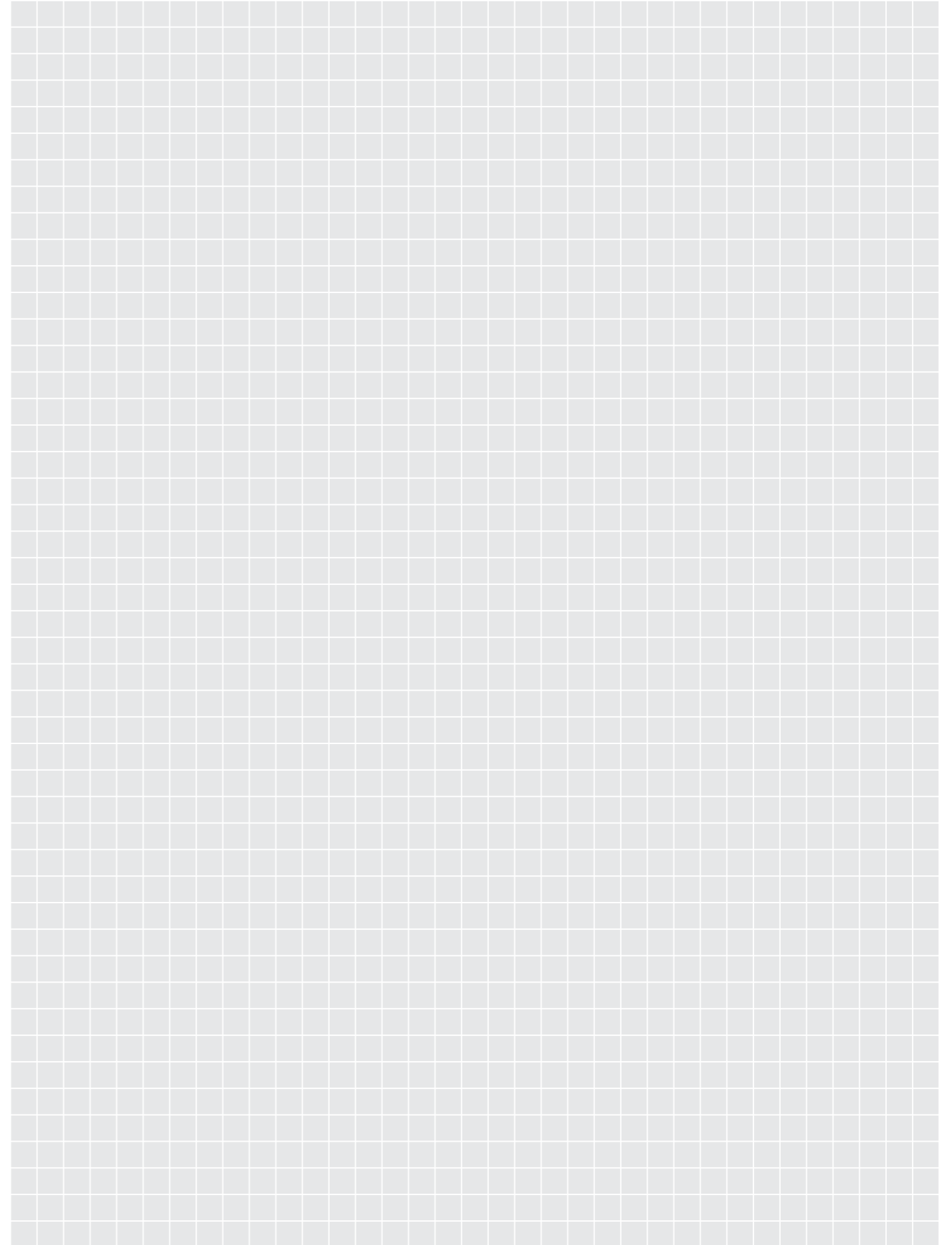

# BE UNSTOPPABLE!

VISIT US AT

